

SC628NP

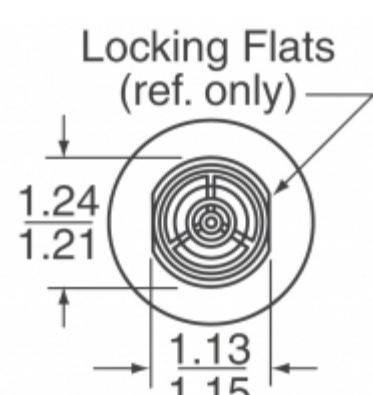

Obrázky jsou pouze orientační.
Podrobné informace o produktu naleznete v části Technické údaje produktu.
Koupit SC628NP s důvěrou od Component-World.HK, 1 rok záruka



Part Number: SC628NP

Výrobce: Mallory Sonalert Products

Popis: AUDIO PIEZO IND 6-28V PNL MNT

Datový list: [Industrial Alarms Product Guide](#)
[SC628NP](#)

RoHS Status: Obsahuje olovený / RoHS neodpovídající

Ship From: Hong Kong

Shipment Way: DHL/Fedex/TNT/UPS/EMS

[Request For Quotation](#)

















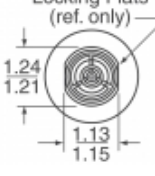



PARAMETR PRODUKTU

Part Number	SC628NP	Výrobce	Mallory Sonalert Products
Popis	AUDIO PIEZO IND 6-28V PNL MNT	Stav volného vedení / RoHS	Obsahuje olovený / RoHS neodpovídající
Dostupné množství	2439 pcs	Datový list	Industrial Alarms Product Guide SC628NP
Kategorie	Audio produkty	Rozsah napětí	6 ~ 28V
Ukončení	Screw Terminal, Quick Connect Tab - 0.250" (6.35mm)	Technika	Piezo
Úroveň akustického tlaku (SPL)	80dB @ 6V, 61cm	Velikost / Rozměry	1.692" Dia (42.98mm)
Série	SC	hodnocení	-
Port Umístění	Top	Obal	Bulk
Provozní teplota	-30°C ~ 65°C	Pracovní režim	Pulse, Fast
Typ montáže	Panel Mount	Úroveň citlivosti na vlhkost (MSL)	1 (Unlimited)
Výrobní standardní doba výroby	4 Weeks	Stav volného vedení / RoHS	Contains lead / RoHS non-compliant
Typ vstupu	DC	Výška - Sedící (Max)	1.330" (33.77mm)
Frekvence	2.9kHz	Trvání	2 ~ 10 PPS
Driver obvod	Indicator, Internally Driven	Detailní popis	Buzzers Indicator, Internally Driven Piezo 4 ~ 16mA 2.9kHz 80dB @ 6V, 61cm Panel Mount Screw Terminal, Quick Connect Tab - 0.250" (6.35mm)
Proud - Supply	4 ~ 16mA	schválení	-

Component-World.com je spolehlivý distributor elektronických součástek. Specializujeme se na všechny elektronické komponenty řady Mallory Sonalert Products. Máme 2439 kusy Mallory Sonalert Products SC628NP na skladě dostupných. Vyžádejte si citát z distributora součástí elektroniky na Component-World.com, náš prodejní tým vás bude kontaktovat do 24 hodin.

RFQ Email: info@Components-World.com

SOUVISEJÍCÍ PRODUKTY

	Část#: SC628NJ	Výrobci: Mallory Sonalert Products	Dotaz
	Popis: AUDIO PIEZO IND 6-28V PNL MNT		
	Část#: SC628NR	Výrobci: Mallory Sonalert Products	Dotaz
	Popis: AUDIO PIEZO IND 6-28V PNL MNT		
	Část#: SC628NJR	Výrobci: Mallory Sonalert Products	Dotaz
	Popis: AUDIO PIEZO IND 6-28V PNL MNT		
	Část#: SC628P-2	Výrobci: Mallory Sonalert Products	Dotaz
	Popis: AUDIO PIEZO IND 6-28V PNL MNT		
	Část#: SC628ND	Výrobci: Mallory Sonalert Products	Dotaz
	Popis: AUDIO PIEZO IND 6-28V PNL MNT		
	Část#: SC628NDP	Výrobci: Mallory Sonalert Products	Dotaz
	Popis: AUDIO PIEZO IND 10-28V PNL MNT		
	Část#: SC628NDPR	Výrobci: Mallory Sonalert Products	Dotaz
	Popis: AUDIO PIEZO IND 10-28V PNL MNT		
	Část#: SC62CB-100	Výrobci: Bel	Dotaz
	Popis: FIXED IND 10UH 1.82A 80 MOHM SMD		
	Část#: SC628NLR	Výrobci: Mallory Sonalert Products	Dotaz
	Popis: AUDIO PIEZO IND 6-28V PNL MNT		
	Část#: SC628P-BTR	Výrobci: Mallory Sonalert Products	Dotaz
	Popis: AUDIO PIEZO IND 6-28V PNL MNT		
	Část#: SC628NL	Výrobci: Mallory Sonalert Products	Dotaz
	Popis: AUDIO PIEZO IND 6-28V PNL MNT		
	Část#: SC628R	Výrobci: Mallory Sonalert Products	Dotaz
	Popis: AUDIO PIEZO IND 6-28V PNL MNT		
	Část#: SC628N-1R	Výrobci: Mallory Sonalert Products	Dotaz
	Popis: AUDIO PIEZO IND 6-28V PNL MNT		
	Část#: SC628NDR	Výrobci: Mallory Sonalert Products	Dotaz
	Popis: AUDIO PIEZO IND 6-28V PNL MNT		
	Část#: SC628PR	Výrobci: Mallory Sonalert Products	Dotaz
	Popis: AUDIO PIEZO IND 6-28V PNL MNT		
	Část#: SC628WR	Výrobci: Mallory Sonalert Products	Dotaz
	Popis: AUDIO PIEZO IND 6-28V PNL MNT		
	Část#: SC628NPR	Výrobci: Mallory Sonalert Products	Dotaz
	Popis: AUDIO PIEZO IND 6-28V PNL MNT		
	Část#: SC628P	Výrobci: Mallory Sonalert Products	Dotaz
	Popis: AUDIO PIEZO IND 6-28V PNL MNT		
	Část#: SC628N-BTR	Výrobci: Mallory Sonalert Products	Dotaz
	Popis: AUDIO PIEZO IND 6-28V PNL MNT		
	Část#: SC628W	Výrobci: Mallory Sonalert Products	Dotaz
	Popis: AUDIO PIEZO IND 6-28V PNL MT		

Související klíčová slova pro SC628NP

Mallory Sonalert Products SC628NP.	SC628NP distributor	SC628NP dodavatel	SC628NP Cena
SC628NP Stáhnout datasheet.	SC628NP Datasheet.	SC628NP Stock.	koupit SC628NP.
Mallory Sonalert Products SC628NP.	Mallory Sonalert Products Inc. SC628NP.		